

Article number: 201463B30562SW

Description: E+G
Flanged Connector GN 146.3-B30-56-2-SW

Measures

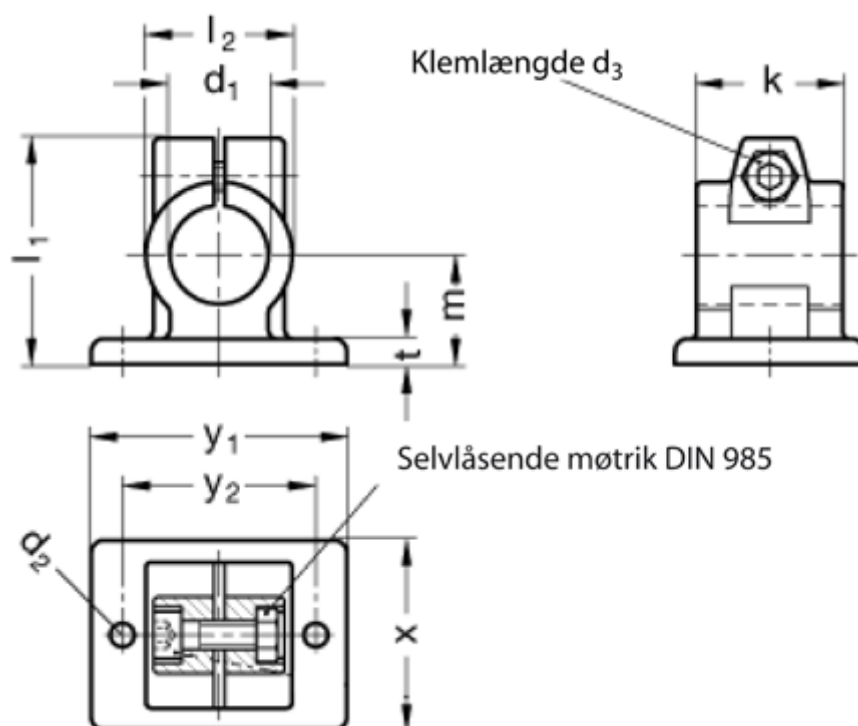

Adjustable clamp lever = GN 911-M10-40 have to be ordred separately

d_1	= B30
d_2	= 8.5
d_3	= M10
k	= 56
l_1	= 83
l_2	= 56
m	= 42

t	= 10
x	= 78
y_1	= 108
y_2	= 82